

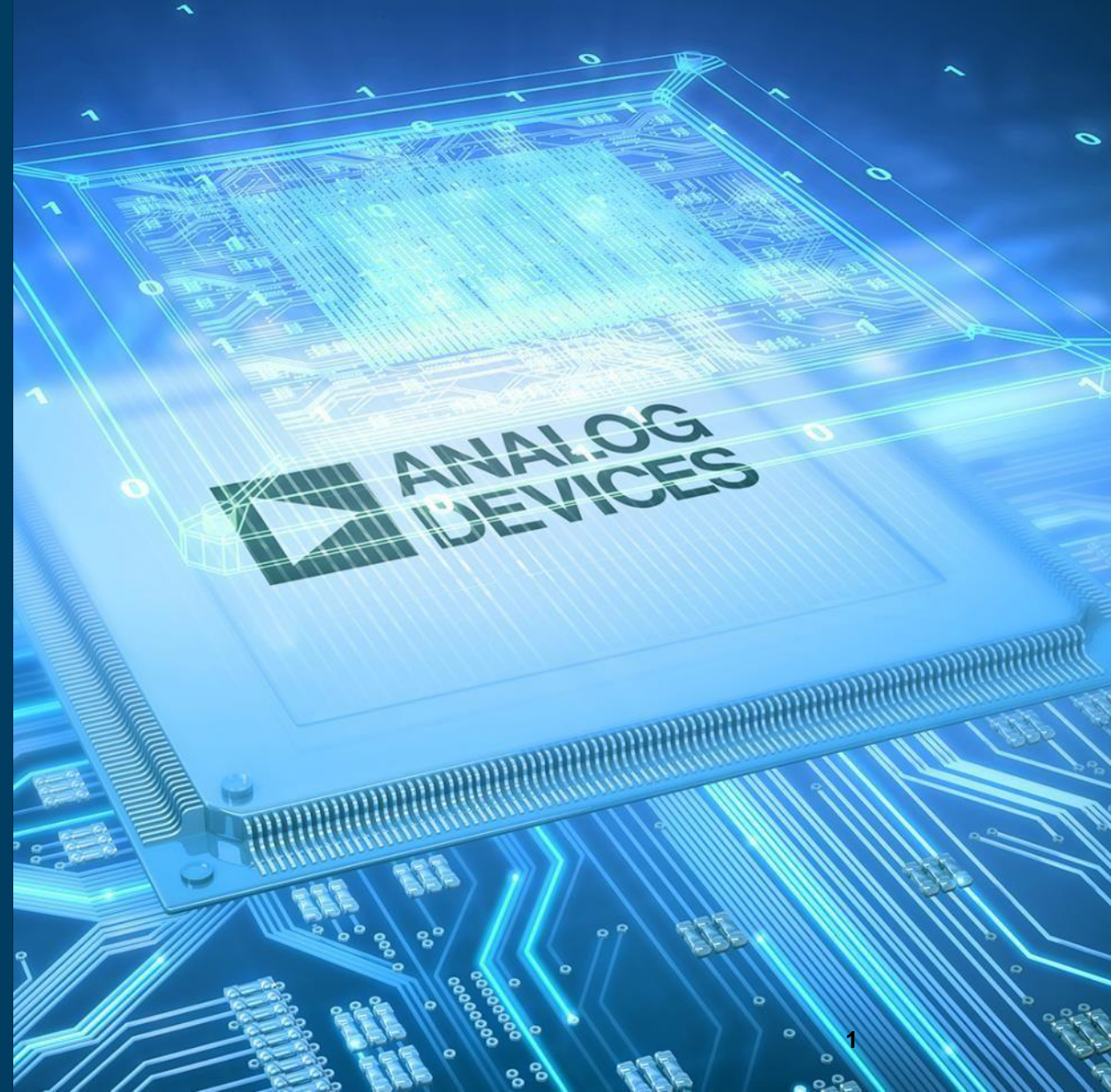

AHEAD OF WHAT'S POSSIBLE™

Explore Power Designs with uModule Products



Agenda for Today

- ▶ What are μ Module Power Products?
- ▶ What Problem are we Solving?
- ▶ Quality & Reliability
- ▶ μ Module Packaging Trends
- ▶ Thermal Performance
- ▶ Product Portfolio Overview
 - 0 to 15A μ Module regulators
 - 25A to 100A+ μ Module Regulators
 - UltraThin μ Module Regulators
 - Dual, Triple & Quad Output μ Modules
 - Component on Package (CoP)
- ▶ Power VLSI Digital & Reference Designs
- ▶ PMBus μ Module Regulators

What is a μ Module Product?

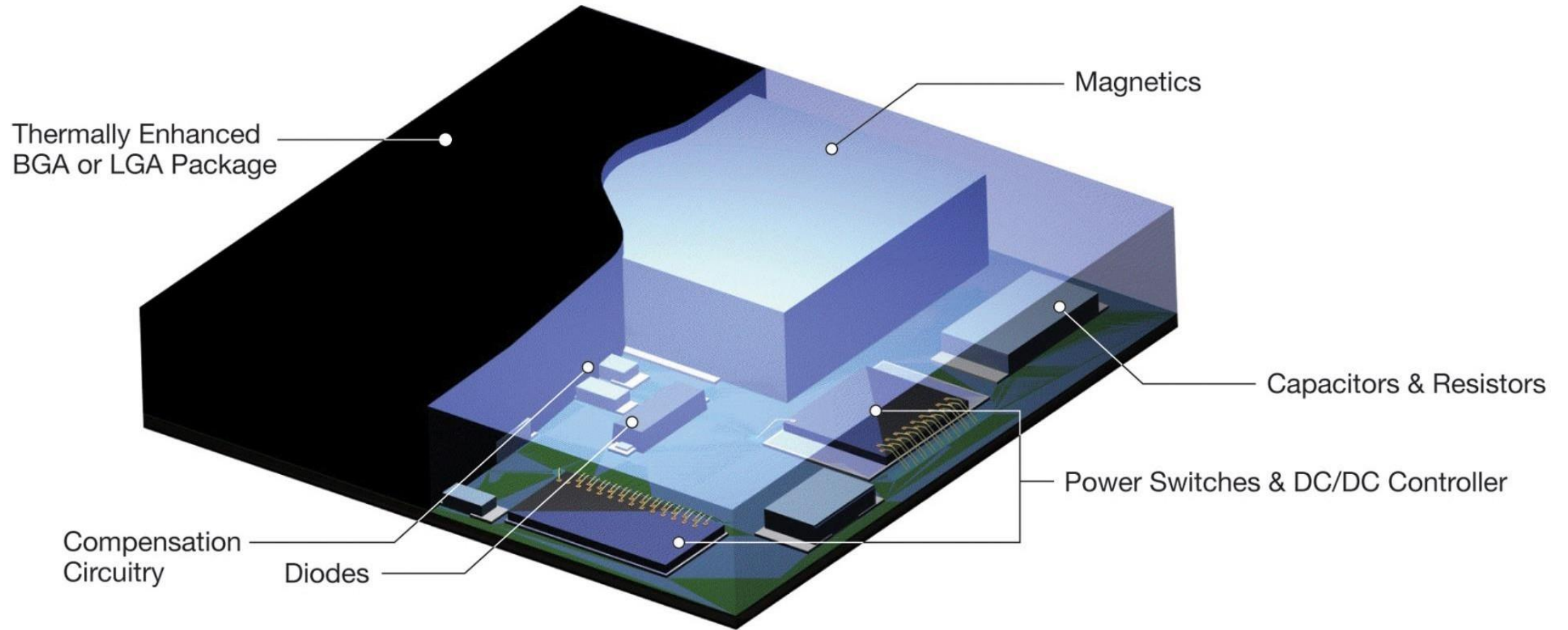

μModule Architecture Advantage: Multi-Layer Substrate

μModule™ BGA Package Construction

(Not To Scale)

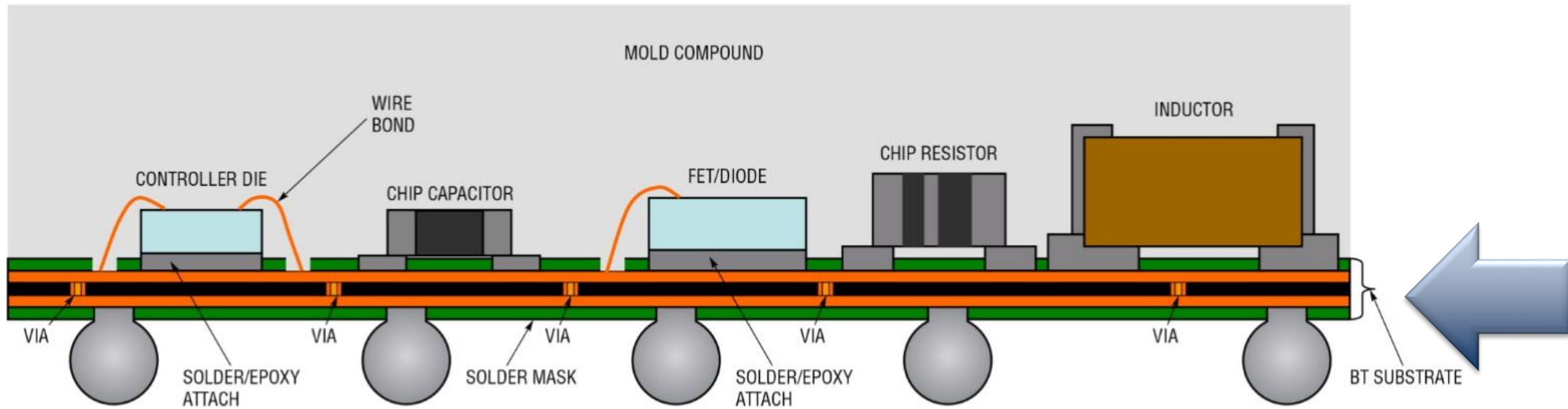

BT is short hand for: Bismaleimide-Triazine
(Pronounced: Biz-mal-ale-ide Tri-a-zine)

What Problem were we Trying to Solve?

- ▶ Switch-mode Power Design Expertise is Declining
- ▶ Available PCB area is at a premium
- ▶ Thermal Design constraints are becoming more complex as Board Densities are Increasing for a given amount of Air Flow
- ▶ Time-to-Market Pressures are more stringent

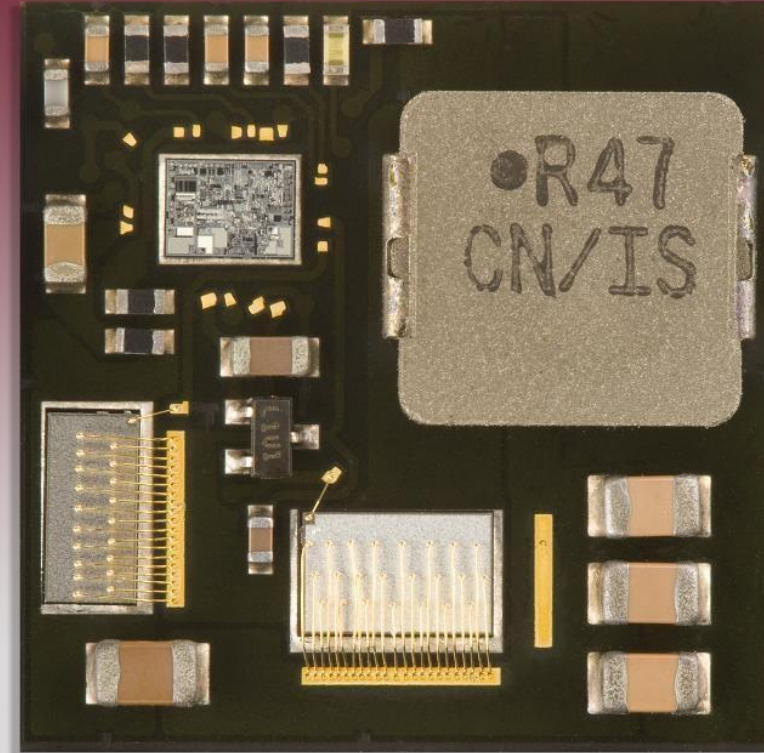

 LINEAR
TECHNOLOGY

LTM4600: 15mm x 15mm x 2.82mm LGA

What Problem were we Trying to Solve?

- ▶ Switch-mode Power Design Expertise is Declining

- ▶ The average age of a Degreed Engineer (BSEE) is 57 years Old across the Globe. [Source: EDN].

- ▶ The top 3 Concerns of these Engineers are:

#1: Insufficient People to get the Job Done

#2: Finding the Optimal Component for my Design

#3: Time-to-Market Pressures

What Problem were we Trying to Solve?

- ▶ Available PCB area is at a premium
- ▶ System Designers are being asked to increase PCB functionality and density in an ever shrinking form factor

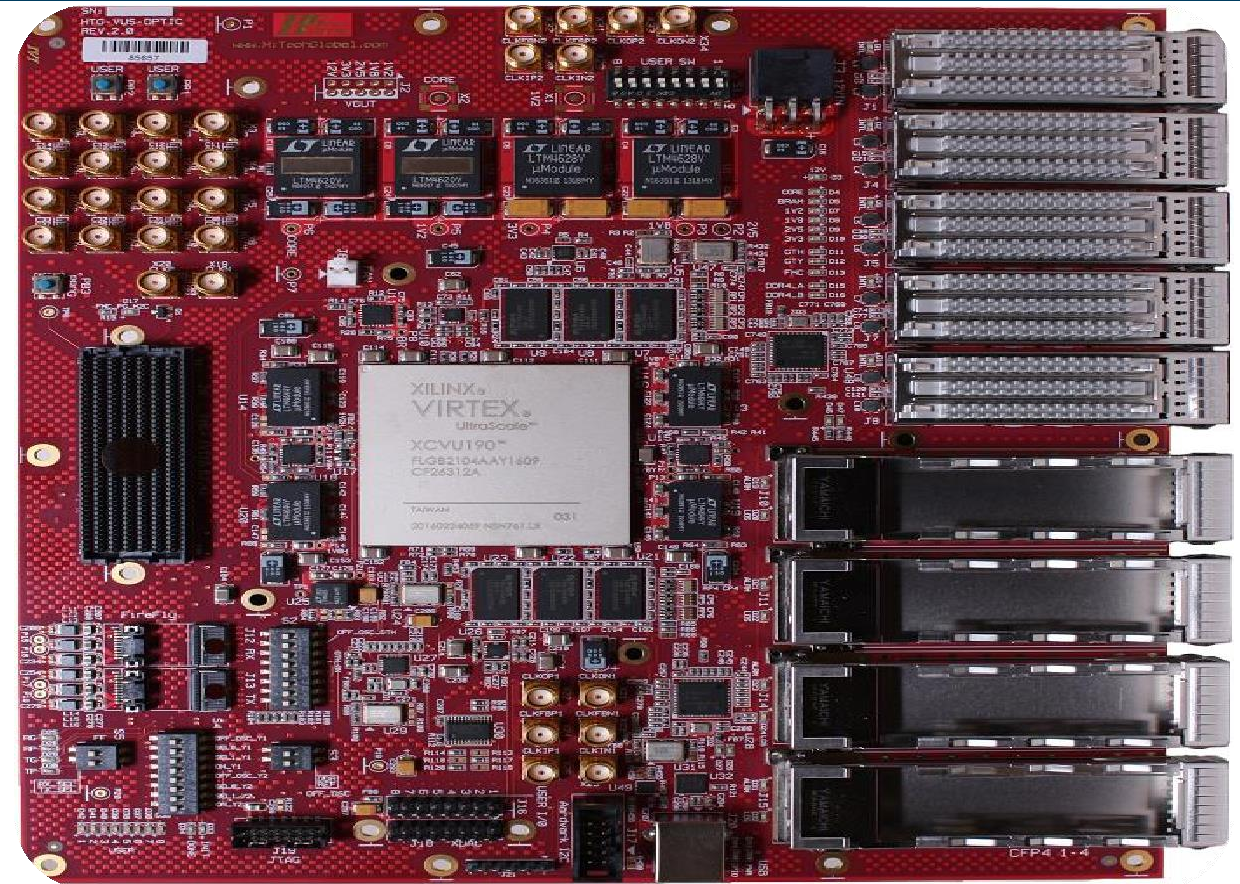

What Problem were we Trying to Solve?

- ▶ Thermal Design constraints are becoming more complex as Board Densities are Increasing for a given amount of Air Flow and/or heat sinking

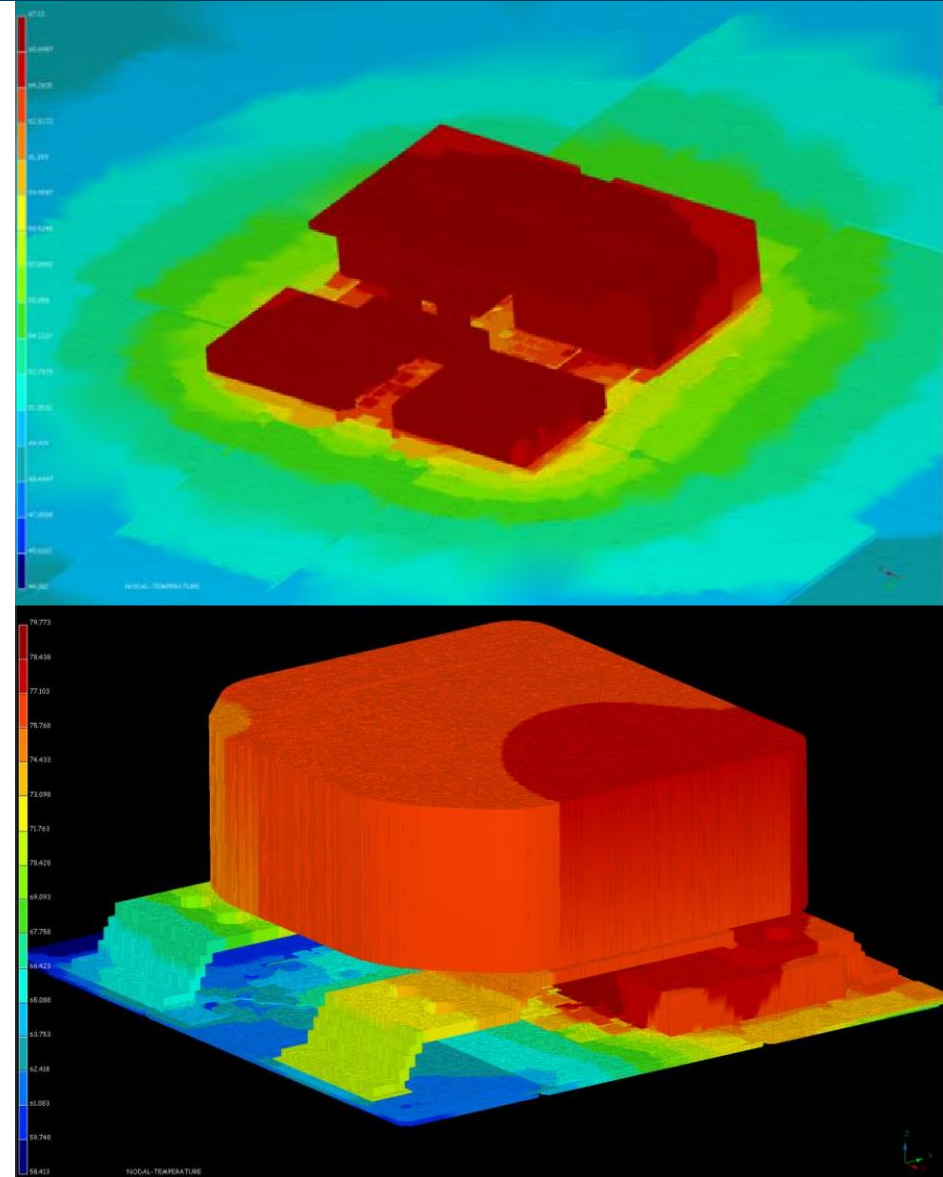

What Problem were we Trying to Solve?

- ▶ Time-to-Market Pressures are more stringent today
- ▶ Who has the time to design and debug their power supply when they are going in to mass production in less than a month?
- ▶ μ Modules provide a “simple and done” proven power conversion solution.
- ▶ No late nights in the lab debugging a power supply!



Power μ Module Product Quality & Reliability

- 22,175,000 Power Cycles
- 5,071,000 High Temp Operating Life (device hours)
- Board Mount Temp Cycles
2,118,000 (-40°C to 125°C)
High Temp Bake (device hours)
43,605,000 at 150°C
- 25,046,000 Temp Cycle -65°C to 150°C
- 16,439,000 Thermal Shock -65°C to 150°C
- FIT Rate: < 0.4
- And many more pages of data posted online
 - 2nd Source Assembly & Manufacturing
 - Multi-sourced Substrate and Component Suppliers
 - Die Bank

Reliability Data Report Report Number: R504

Report generated on: Thu Jan 19 17:03:24 PST 2017

TEMP CYCLE FROM -55 TO 125 DEG C					
PACKAGE TYPE	SAMPLE SIZE	OLDEST DATE CODE	NEWEST DATE CODE	K DEVICE CYCLES	No. of FAILURES
BGA 06X06	883	1245	1527	476	0
BGA 09X11	307	1414	1532	349	0
BGA 15X09					
BGA 11X15					
BGA 15X15					
BGA 16X16					
LGA 06X06					
LGA 15X09					
LGA 11X15					
LGA 15X15					
LGA 16X16					
Totals					

OPERATING LIFE TEST					
PACKAGE TYPE	SAMPLE SIZE	OLDEST DATE CODE	NEWEST DATE CODE	K DEVICE HRS (+125°C) ¹	No. of FAILURES ^{2,3}
BGA 06X06	271	1206	1338	271	0
BGA 15X09	306	1228	1306	306	0
BGA 15X15	911	1141	1428	834	0
BGA 16X16	306	1324	1533	306	0
LGA 06X06	154	1430	1449	154	0
LGA 15X09	788	0634	0643	788	0
LGA 15X15	2448	0452	1223	2297	0
LGA 16X16	153	1233	1247	115	0
Totals	5,337			5,071	0

HIGHLY ACCELERATED STRESS TEST AT +130 DEG C / 85% RH					
PACKAGE TYPE	SAMPLE SIZE	OLDEST DATE CODE	NEWEST DATE CODE	K DEVICE HRS (+85°C) ⁴	No. of FAILURES
BGA 06X06	201	1337	1527	771	0
BGA 09X11	305	1414	1532	961	0
BGA 15X09	1149	1306	1525	3998	0
BGA 15X15	958	1235	1530	2563	0
BGA 16X16	1258	1334	1535	3102	0
LGA 06X06	689	1338	1524	2497	0
LGA 15X09	77	1502	1502	147	0
LGA 15X15	3591	0645	1544	10130	0
LGA 16X16	434	1248	1447	913	0
Totals	8,662			25,082	0

PRESSURE COOKER TEST AT 15 PSIG, +121 DEG C					
PACKAGE TYPE	SAMPLE SIZE	OLDEST DATE CODE	NEWEST DATE CODE	K DEVICE HRS	No. of FAILURES
LGA 15X09	50	1505	1505	1	0
Totals	50			1	0

TEMP CYCLE FROM -40 TO 125 DEG C					
PACKAGE TYPE	SAMPLE SIZE	OLDEST DATE CODE	NEWEST DATE CODE	K DEVICE CYCLES	No. of FAILURES
LGA 15X09	78	0710	0710	78	0
LGA 15X15	230	0632	0642	230	0
Totals	306			306	0

(1) Assumes Activation Energy = 1.0 Electron Volts
 (2) Failure Rate Equivalent to +55 °C, 60% Confidence Level = 0.36 FITS
 (3) Mean Time Between Failure in Years = 315776.72
 (4) Assumes 20X Acceleration from 85 °C to +130 °C
 Note 1: 1 FIT = 1 Failure in One Billion Hours.
 Note 2: HAST, Temp Cycle & Thermal Shock are subjected to J-STD-020 MSL Preconditioning

Packaging Trends: LGA & BGA Package Options

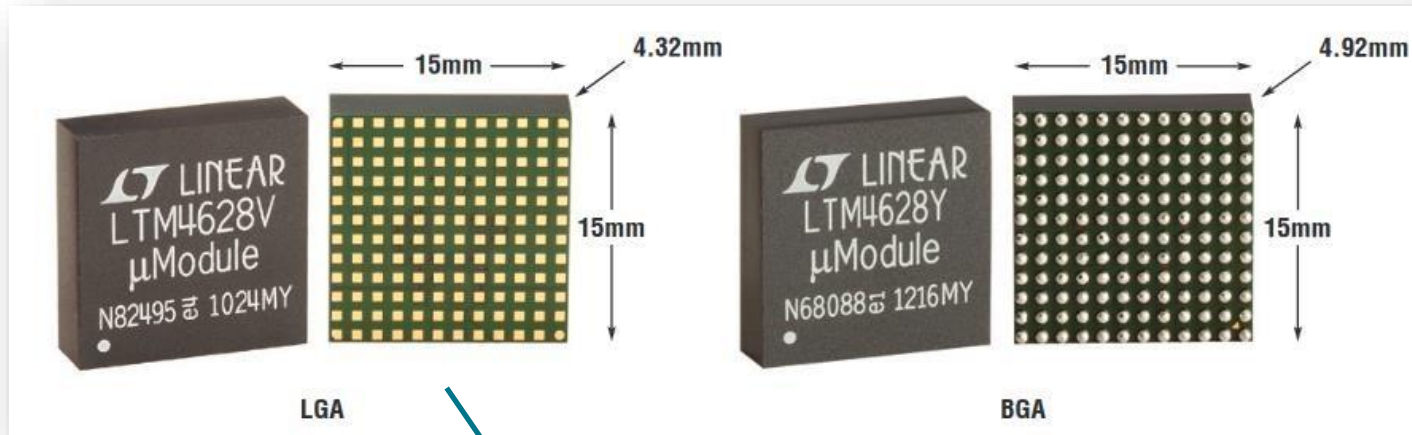

Uniformly Spaced, Equal Size Pads (BGA or LGA):

For simpler, quicker and Error-Free PCB Layout
(symbols and footprints available on-line)

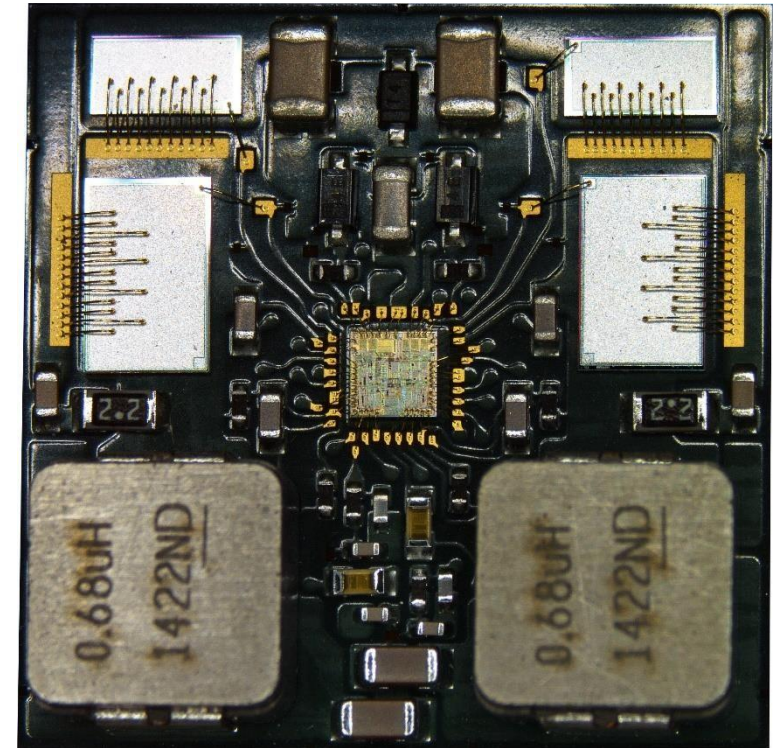

µModule Packaging Trend Evolution

Ultrathin µModule Power Products

1.82mm to 1.91mm LGA

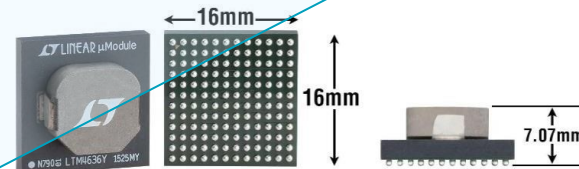
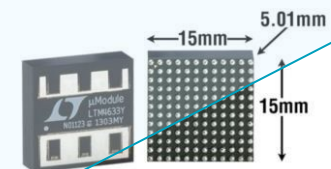
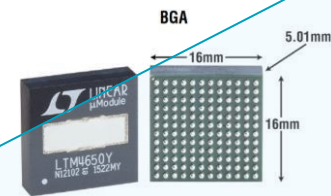
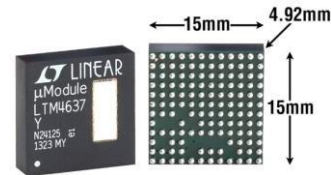
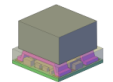
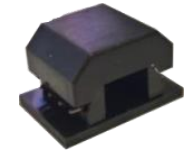
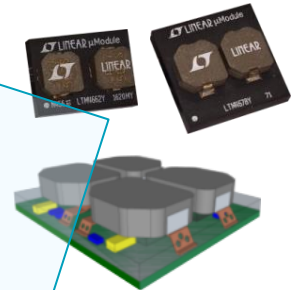
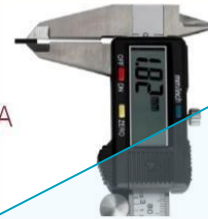

Started: 2010-2014

Started: 2014-2016

Started: 2016-2017

New: 2018-2021

Thermal Performance

► Early Lower Power μ Module Regulators

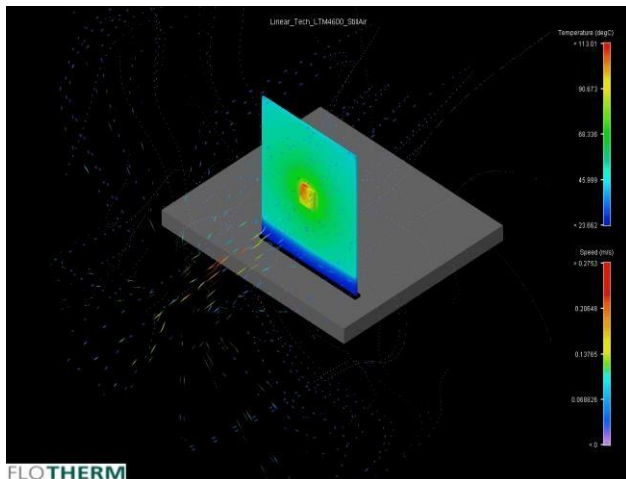
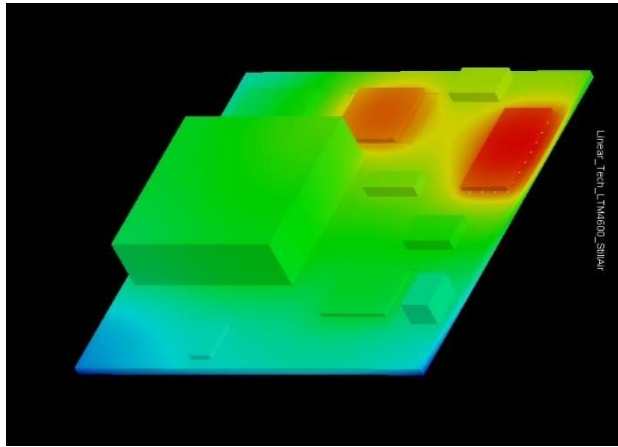

► Heat Sink Power μ Module Regulators

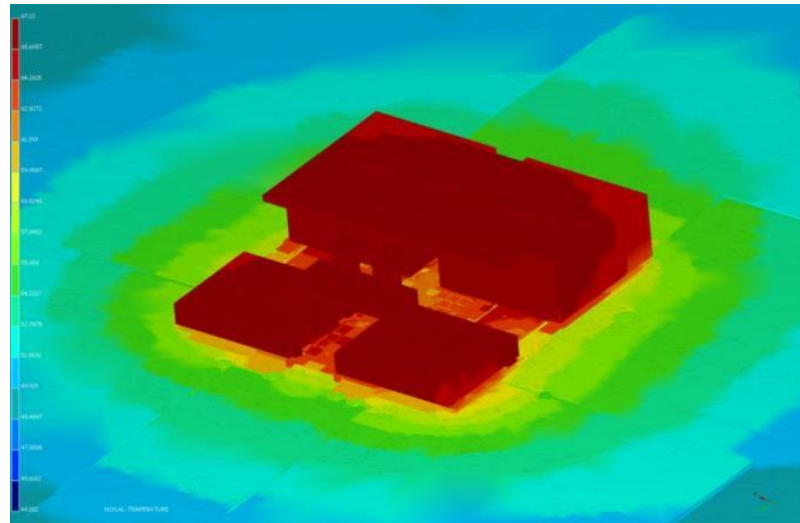
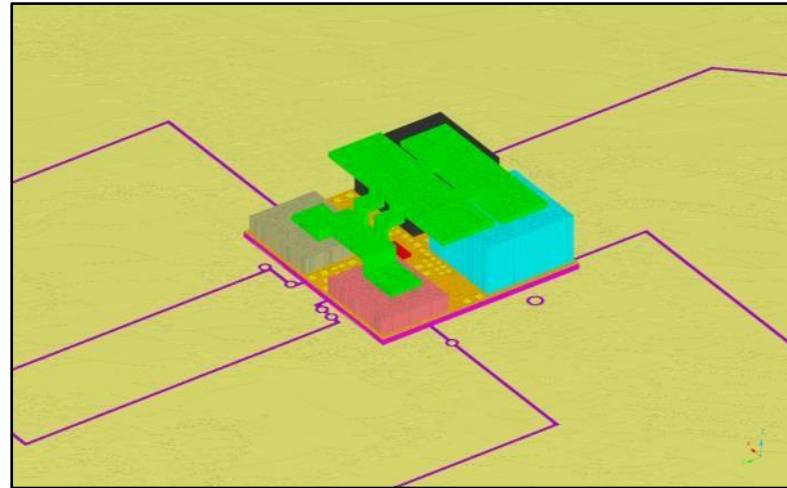

► Component on Top μ Module Regulators

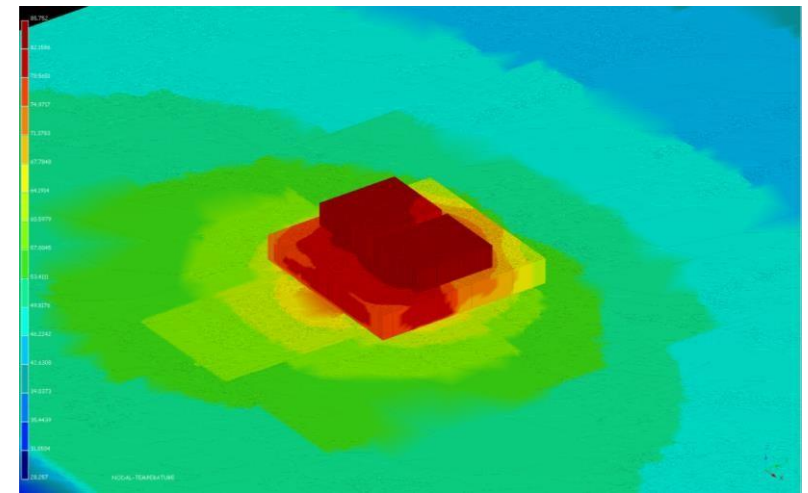
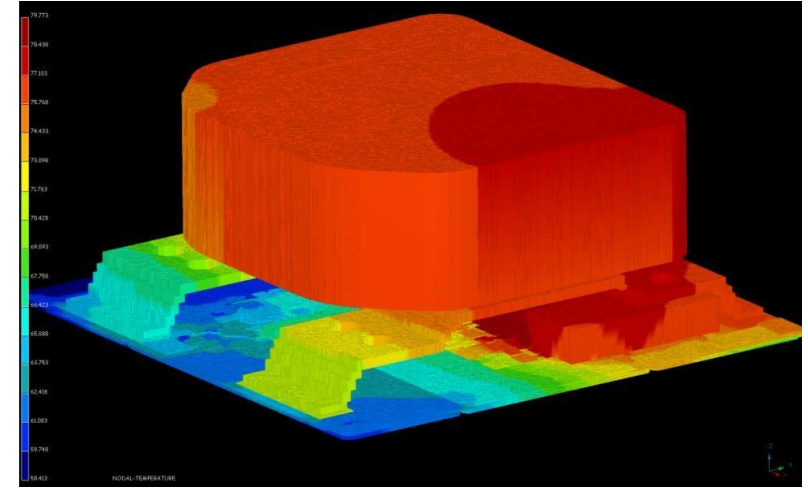

15A Output μ Modules

LTM4638
(June-July 2018)

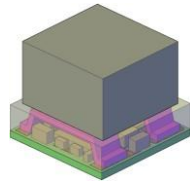

6.25mm x 6.25mm x 5.02mm BGA

LTM4627
(4 years ago)



15mm x 15mm x 4.92mm BGA

25A to 100A+ Output μ Modules

26A-50A
2013-2016

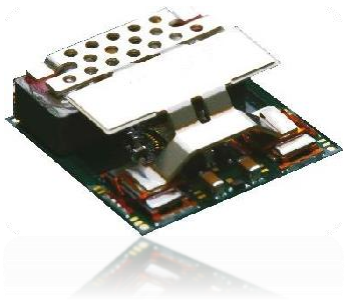

40A+ with 88%-89% Efficiency
2016 Onwards

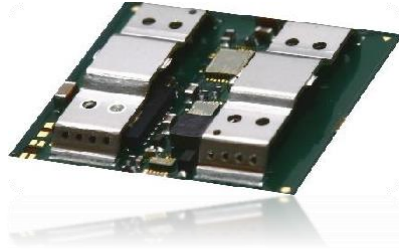

80A-100A+ with High Voltage & Feature Rich
2018 Onwards

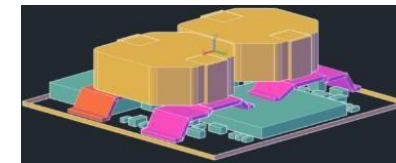
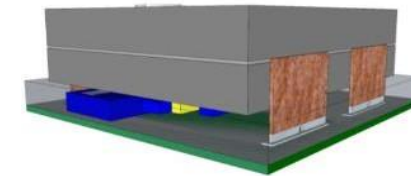
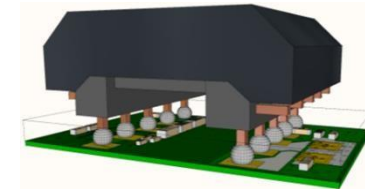

The Road to a 100A μ Module : How did we get there?

2010 :

12x LTM4601



2012 :

4x LTM4620

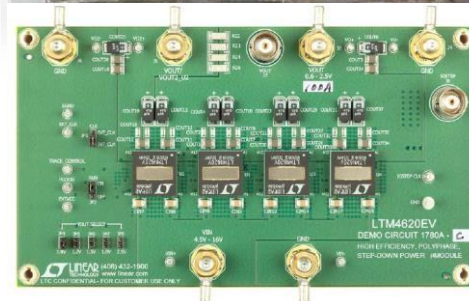

2014 :

3x LTM4630

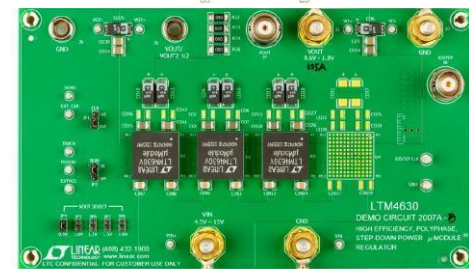

2016 :

2x LTM4650

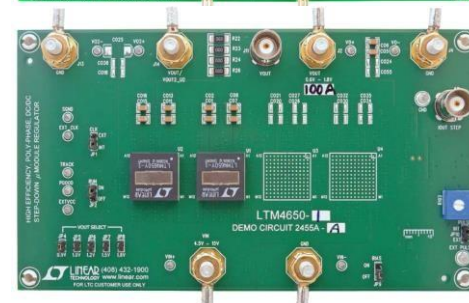

Single 100A μ Module

1 x LTM4700 with
Digital Telemetry
(July-August 2018)



12 x LTM4601
(8 years ago)



LTM4700: 100A μ Module Regulator Summary

- ▶ LTM4700: Single 100A Output or Dual 50A Output
- ▶ Close to 90% Efficient from 12V to 1V at 100A Output with 200LFM
- ▶ Footprint is 15mm x 22mm x 7.82mm
- ▶ Release date is July 2018

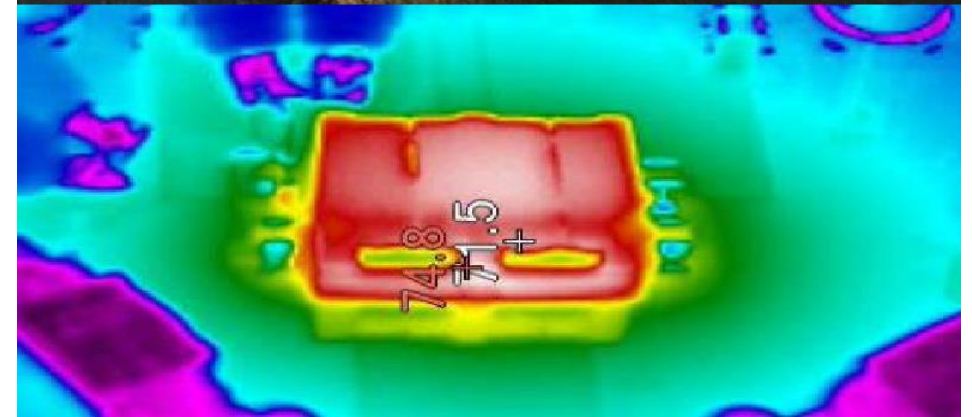
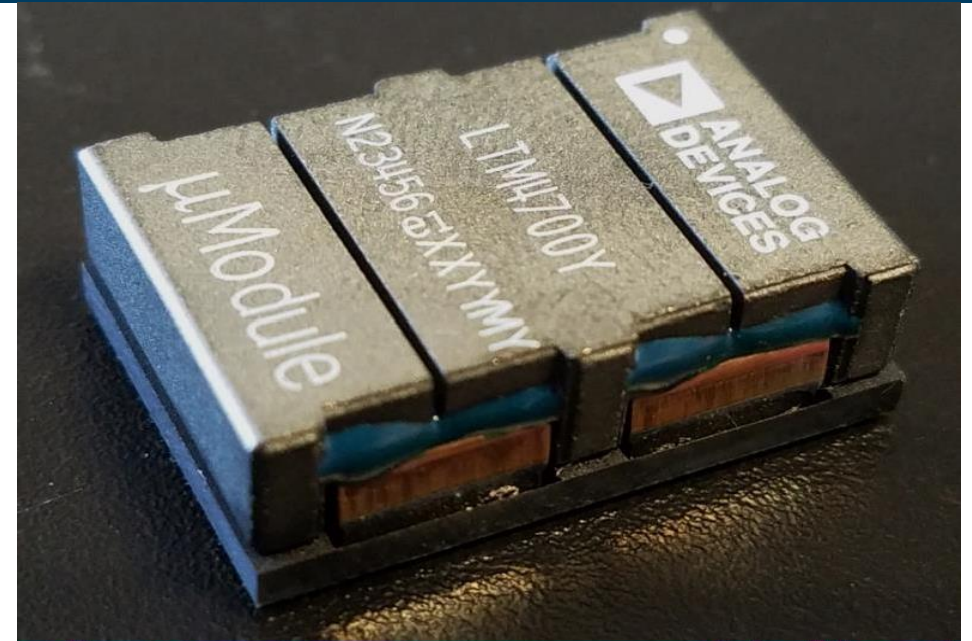

LTM4700 1st 100A μ Module (89.6% efficiency)

LTM4700: Single 100A / Dual 50A μ Module Regulator with Digital PSM

FEATURES

- Dual 50A Digitally Adjustable Outputs with Digital Interface for Control, Compensation and Monitoring
- Wide Input Voltage : 4.5V to 16V
- Output Voltage Range: 0.5V to 1.8V
- $\pm 0.5\%$ Maximum DC Output Error Over Temperature
- $\pm 2.5\%$ Current Readback Accuracy
- Integrated Input Current Sense Amplifier
- 400kHz PMBus-Compliant I²C Serial Interface
- Supports Telemetry Polling Rates Up to 125Hz
- Integrated 16-Bit $\Delta\Sigma$ ADC
- Constant Frequency Current Mode Control
- Parallel and Current Share Multiple Modules
- 15mm \times 22mm \times 7.82mm BGA Package

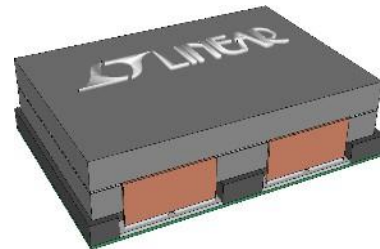

12V Input Efficiency

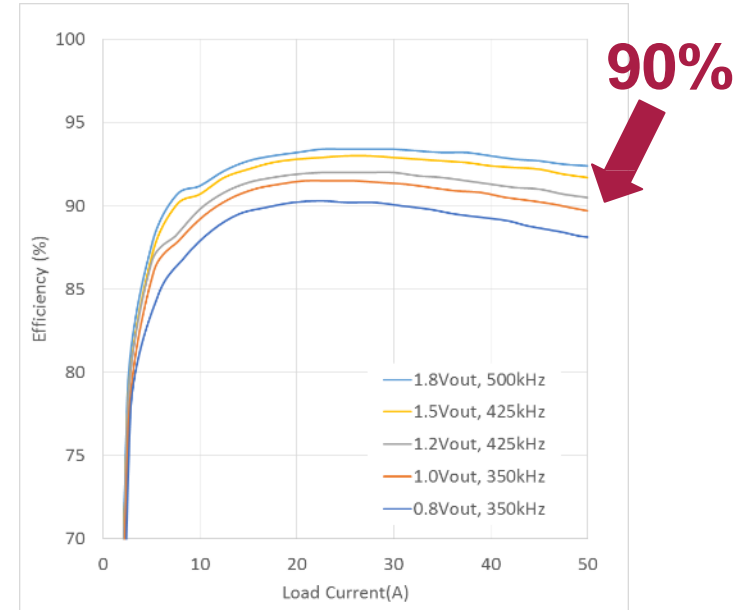

12V to 1V at 100A, 200LFM Airflow

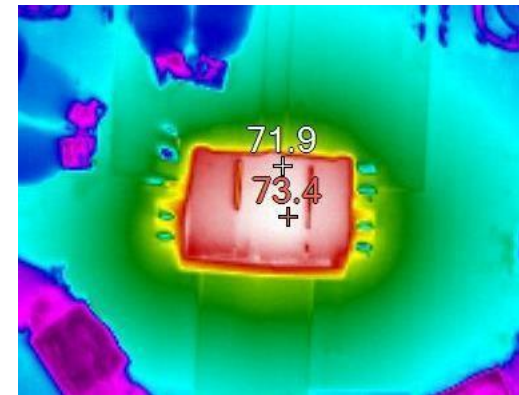

Higher Power Scaling: From 50A to 500A+

Ex: 5 x 50A = 250A
with I2C Digital Telemetry

Ex: 36A + 7 x 50A = 386A
with I2C Digital Telemetry

µModule Solution Advantage:

- ▶ Precise sharing of total output current among each µModule regulator
- ▶ Heat is uniformly distributed too.
- ▶ High reliability: no thermal stress on one device

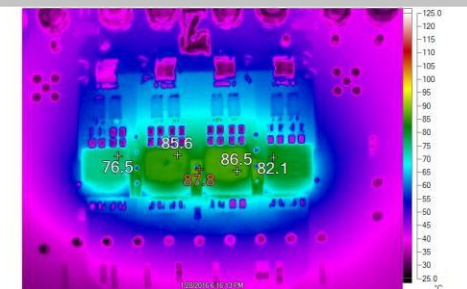
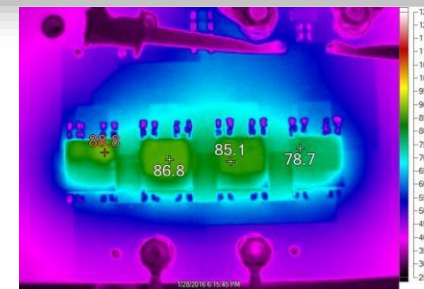
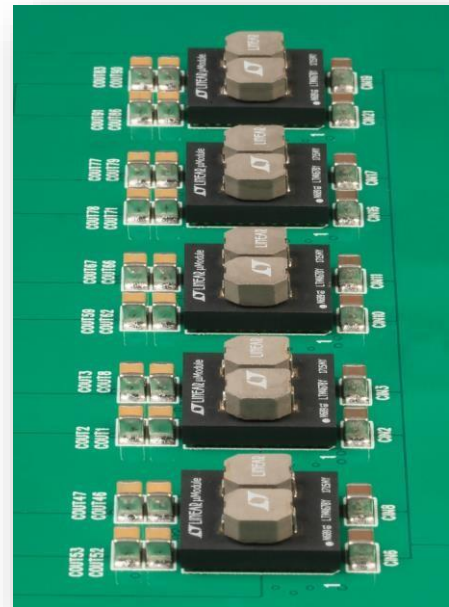

Ultrathin Packages have 2 Benefits: Use Existing Heat sink or utilize the underside of the PCB

Ultrathin μ Module Power Products

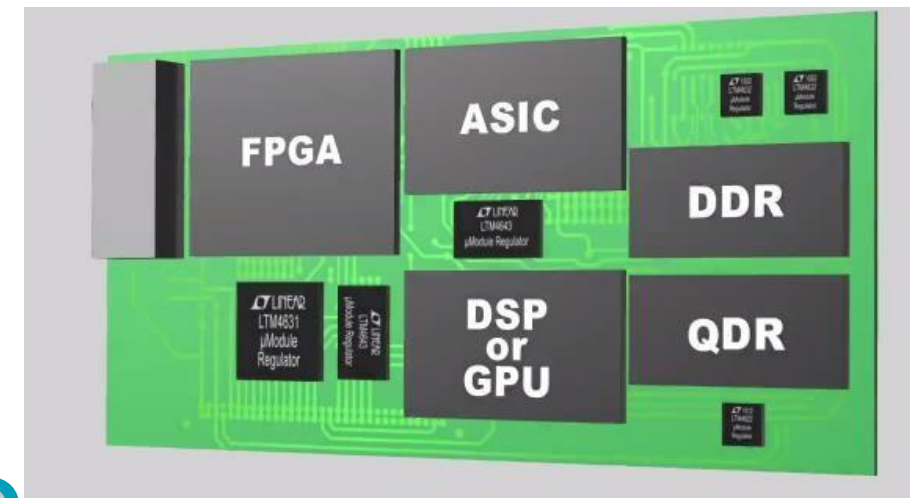
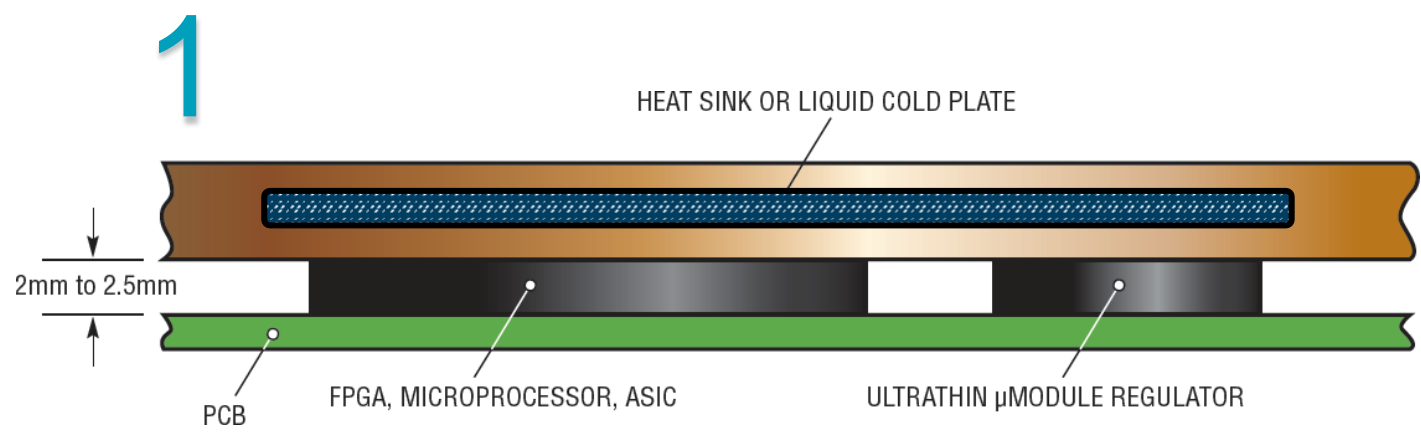
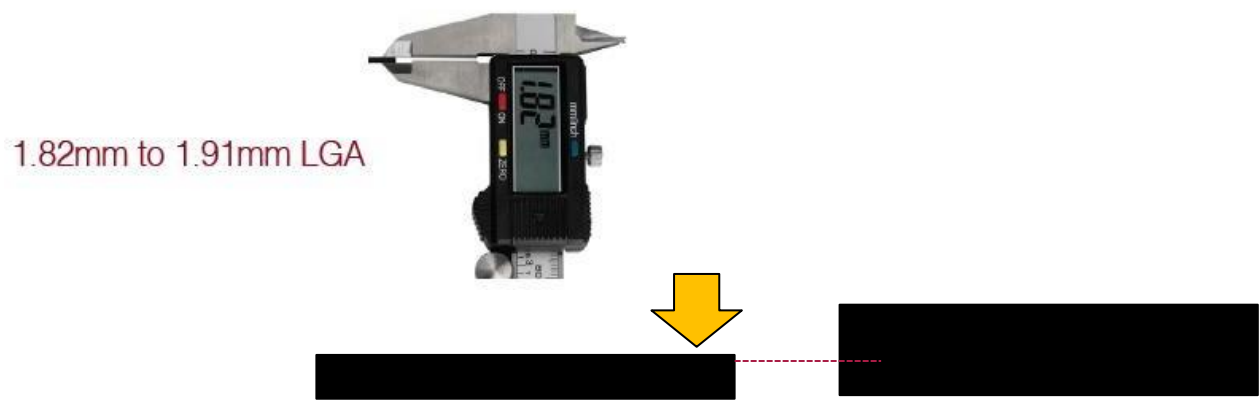

Ultrathin Quad 3A μ Module – LTM4643

- ▶ 4 x 3A Outputs
- ▶ Footprint is 15mm x 9 mm x 1.82mm
- ▶ Input Voltage Range: 4V to 20V (Down to 2.475 with external bias supply)
- ▶ Output Voltage Range: 0.6V to 3.3V
- ▶ $\pm 1.5\%$ Total Output Voltage Regulation
- ▶ Outputs can current share for Configuration Flexibility:
 - ▶ 1 Output of 12A
 - ▶ 2 Outputs of 6A each or 3A & 9A
 - ▶ 3 Outputs of 6A, 3A & 3A
 - ▶ 4 Outputs of 3A, 3A, 3A & 3A

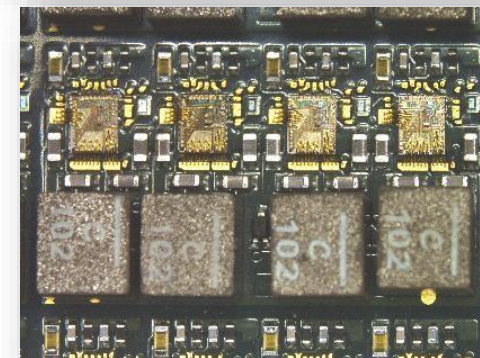
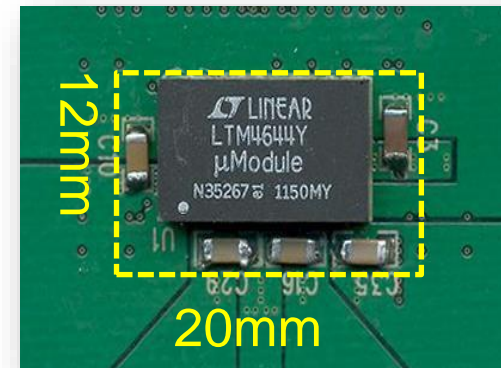
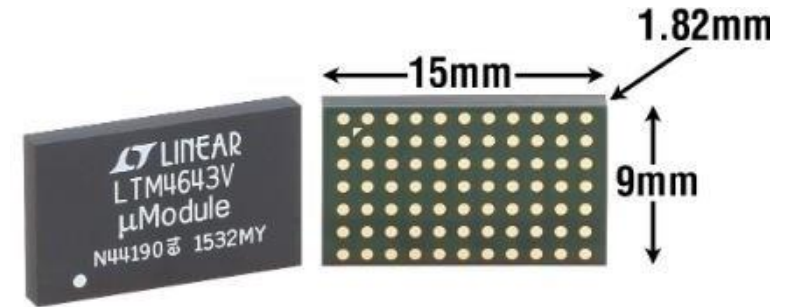

LTM4644: Quad 4A μ Module Regulator

LTC3605
4 x 4A Monolithic Regulators

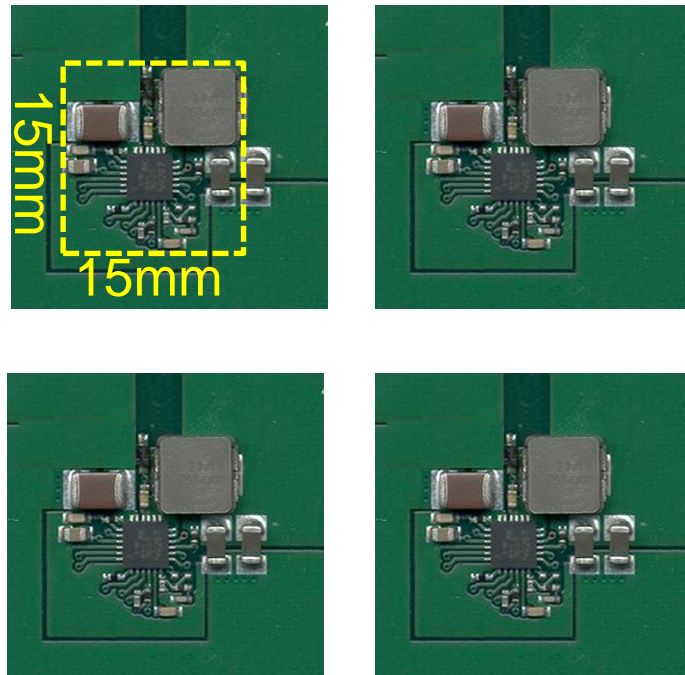

LTM4644
Quad 4A μ Module Regulator

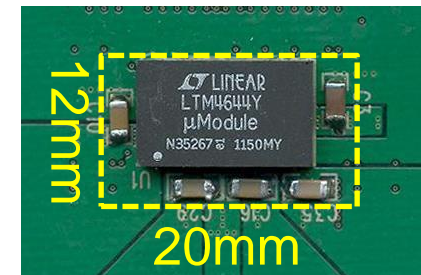

- 900 mm^2 vs. $240 \text{ mm}^2 = 73\%$ reduction

CoP: Component-on-Package

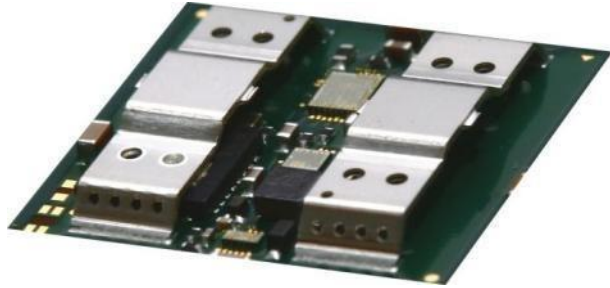

LTM4636 CoP unmolded

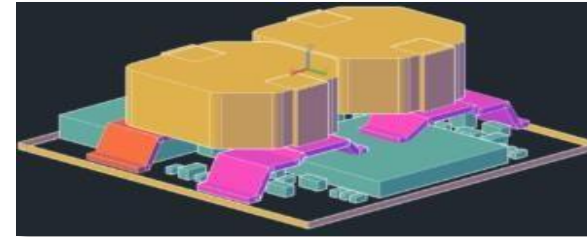

LTM4678 mCoP 3D design
(Jan. 2018 release)

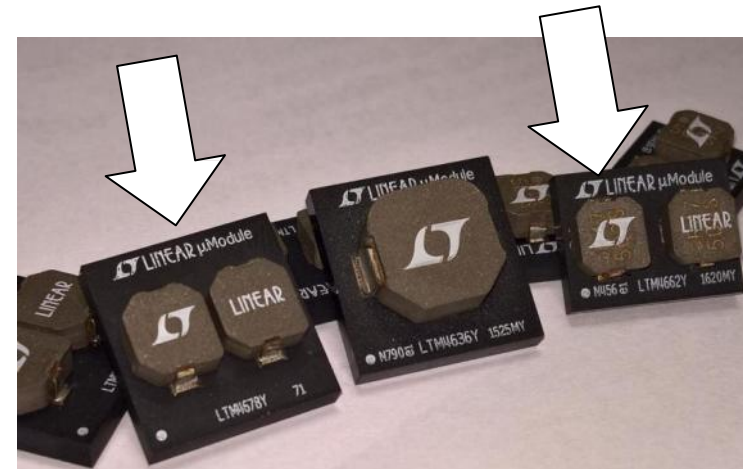
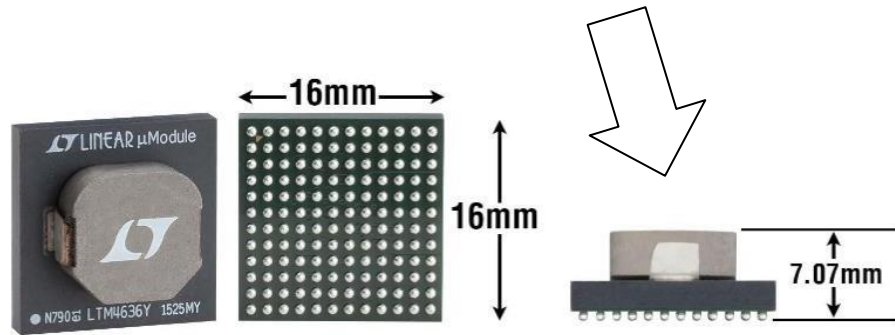

VLSI Digital Ics: We Are Ready To Power Them

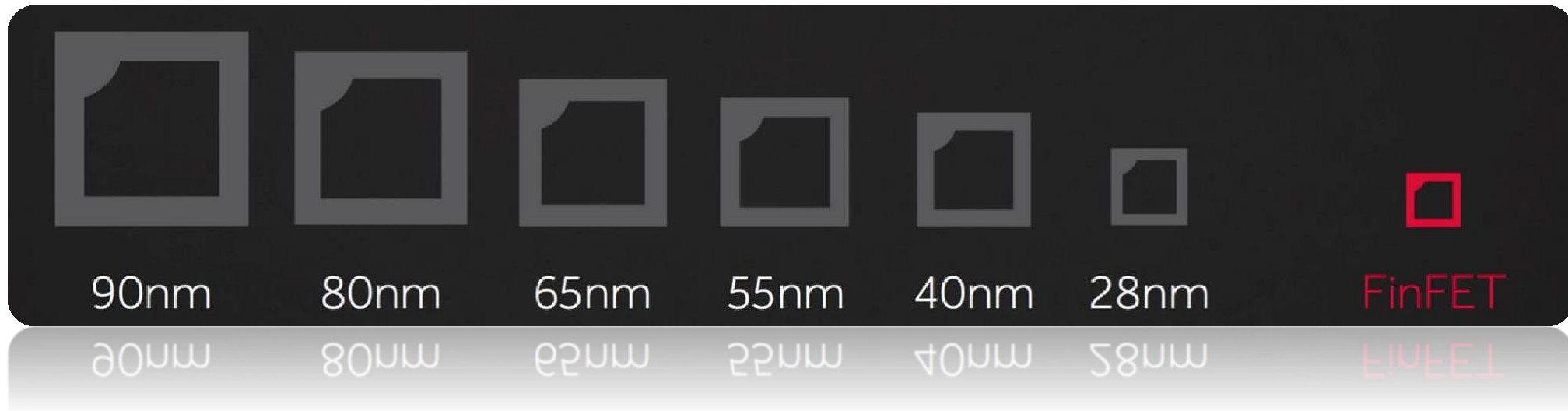

Leader in Providing Power Management for 40nm... sub-10nm-Based Systems Since 2009



Solve The Larger Puzzle ▶ Cheaper, Smaller, Better

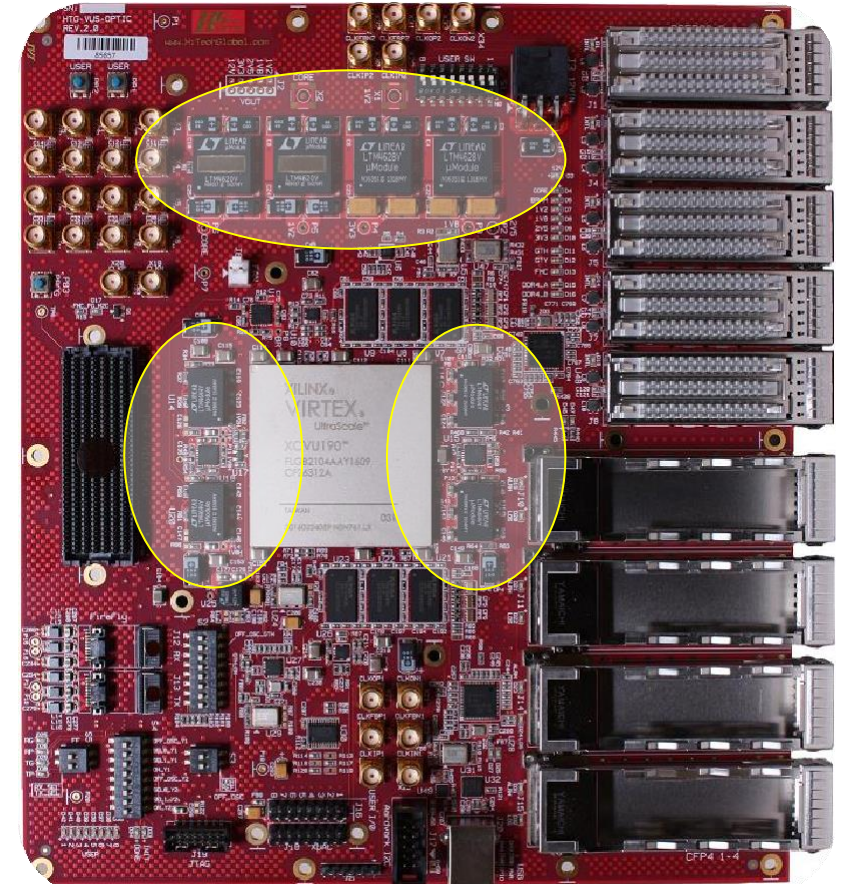
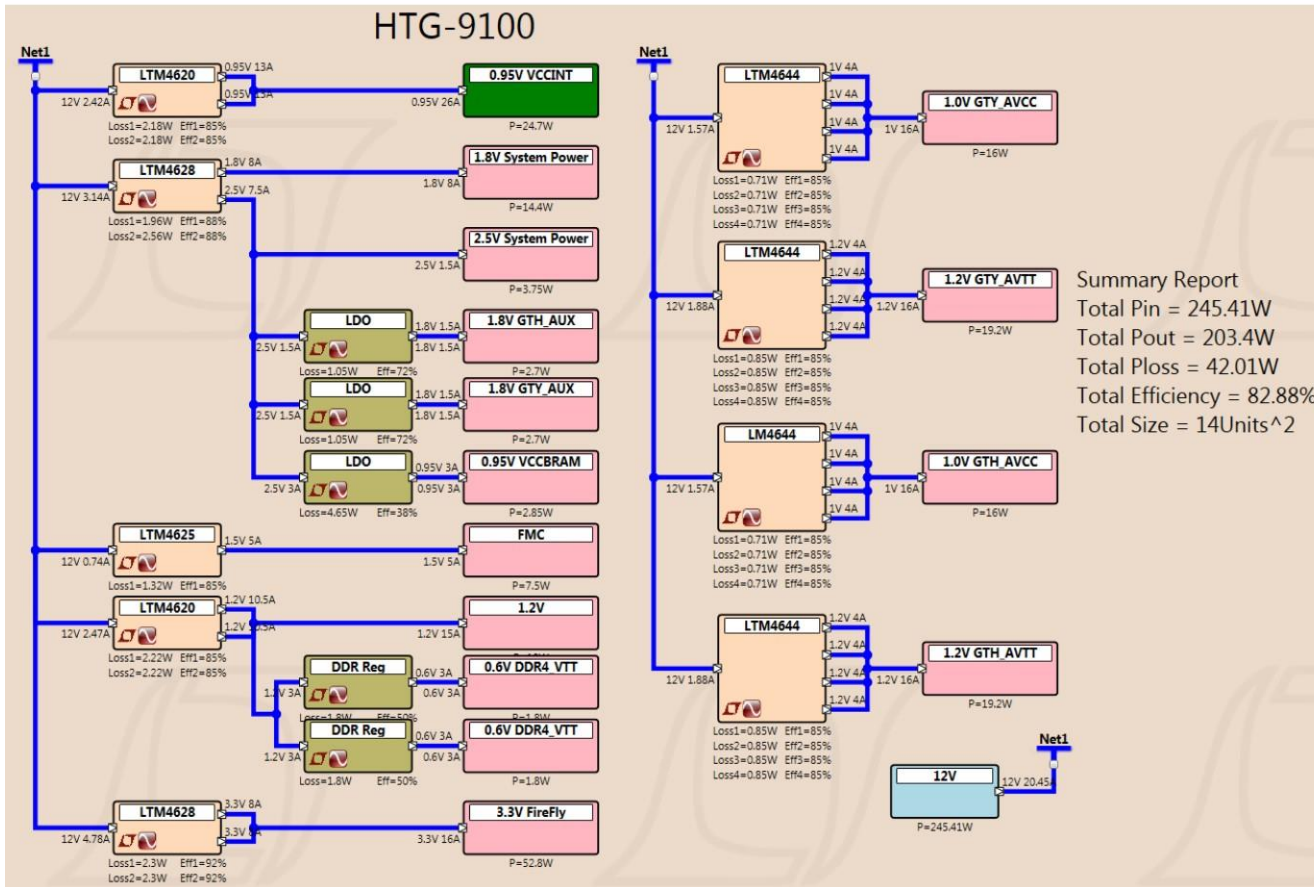

Power for FPGA, Processors & Rest of System - Reference Designs

The examples of actual application board “Tested and Verified” by the board suppliers

**Power Management Solutions
for Xilinx® FPGAs**
Tested and Verified

- ▣ Schematics
- ▣ Bill-of-Materials
- ▣ Power Circuit Simulation & Design Tools
- ▣ www.linear.com/xilinx

HiTech Global Xilinx Kintex® UltraScale® PCI Express Platform

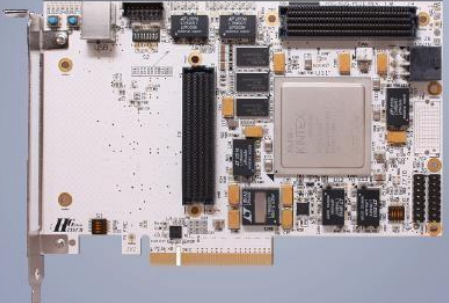

**Power Management Solutions
for Altera FPGAs**
Tested and Verified

- ▣ Schematics
- ▣ Bill-of-Materials
- ▣ Power Circuit Simulation & Design Tools
- ▣ www.linear.com/Altera

Altera Arria® 10 GX FPGA Development Kit



**Power Management Solutions
for NXP Processors**
Tested and Verified

- ▣ www.linear.com/nxp
- ▣ Schematics
- ▣ Bill-of-Materials
- ▣ Power Circuit Simulation & Design Tools

QorIQ LS1088A Reference Design (LS1088A-RDB)

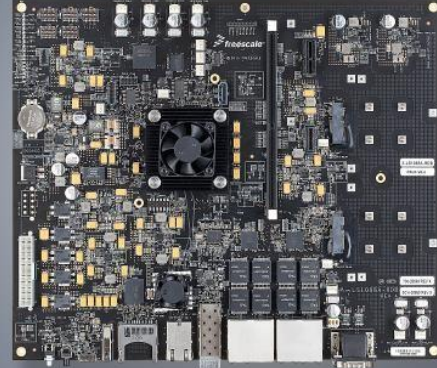

High Current μ Module Regulator Roadmap with Power System Management (PSM)

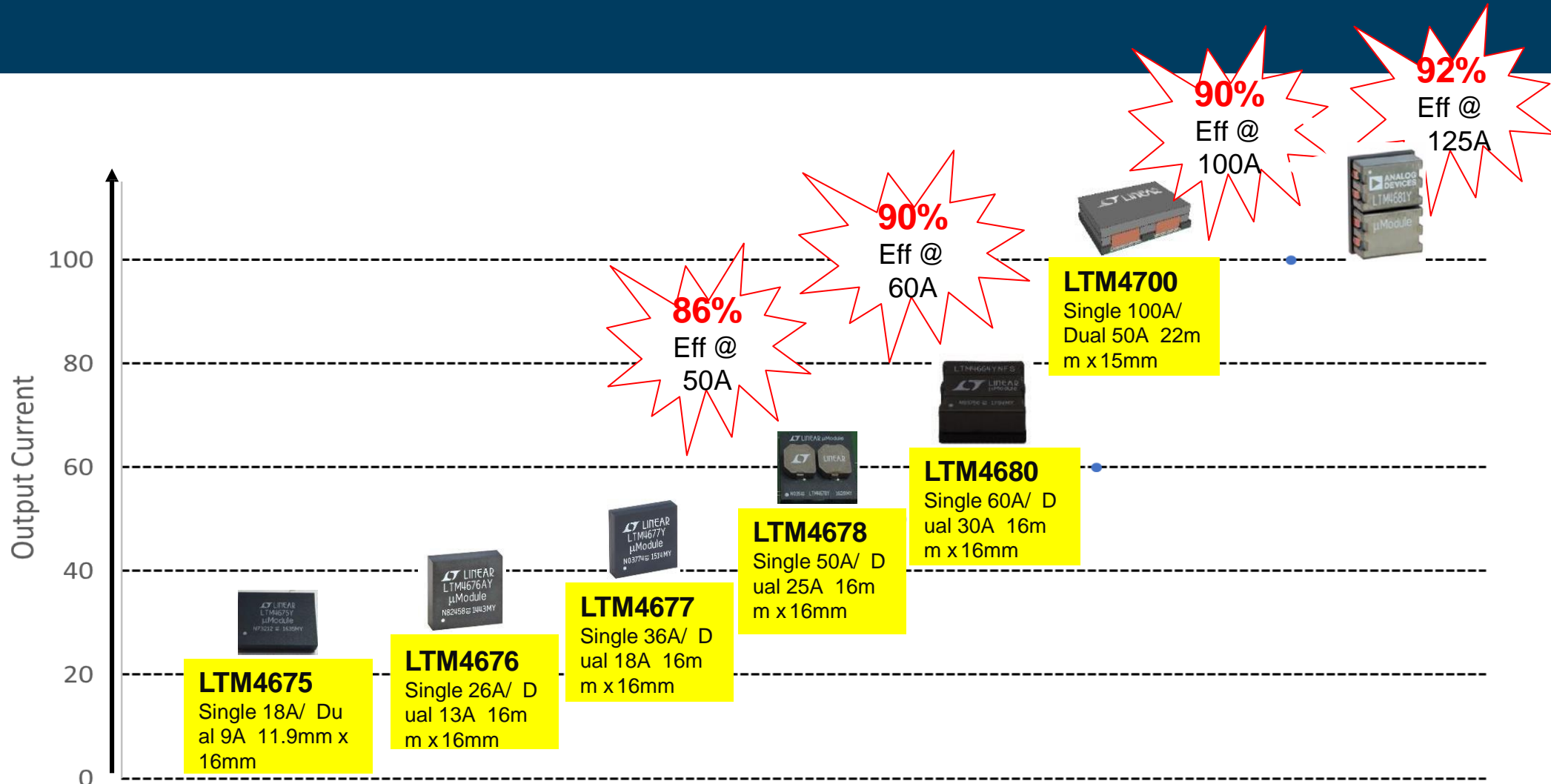

LTM4678 Dual 25A or Single 50A μ Module Regulator with Digital PSM

FEATURES

- Dual Digitally Adjustable Analog Loops with Digital Interface for Control and Monitoring
- Wide Input Voltage Range: 4.5V to 16V
- Output Voltage Range: 0.5V to 1.8V
- $\pm 0.5\%$ Maximum DC Output Error Over Temperature
- $\pm 2.5\%$ Current Readback Accuracy
- Sub-Milliohm DCR Current Sensing
- Integrated Input Current Sense Amplifier
- 400kHz PMBus-Compliant I²C Serial Interface
- Supports Telemetry Polling Rates up to 125Hz
- Integrated 16-Bit $\Delta\Sigma$ ADC
- Constant Frequency Current Mode Control
- Parallel and Current Share Multiple Modules
- 16mm \times 16mm \times 5.74mm BGA Package

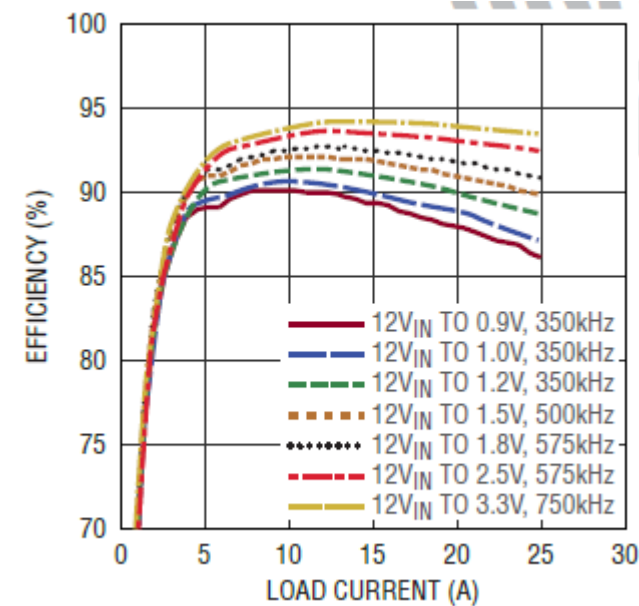

Next Generation Telecom 48V Bus Power Architecture

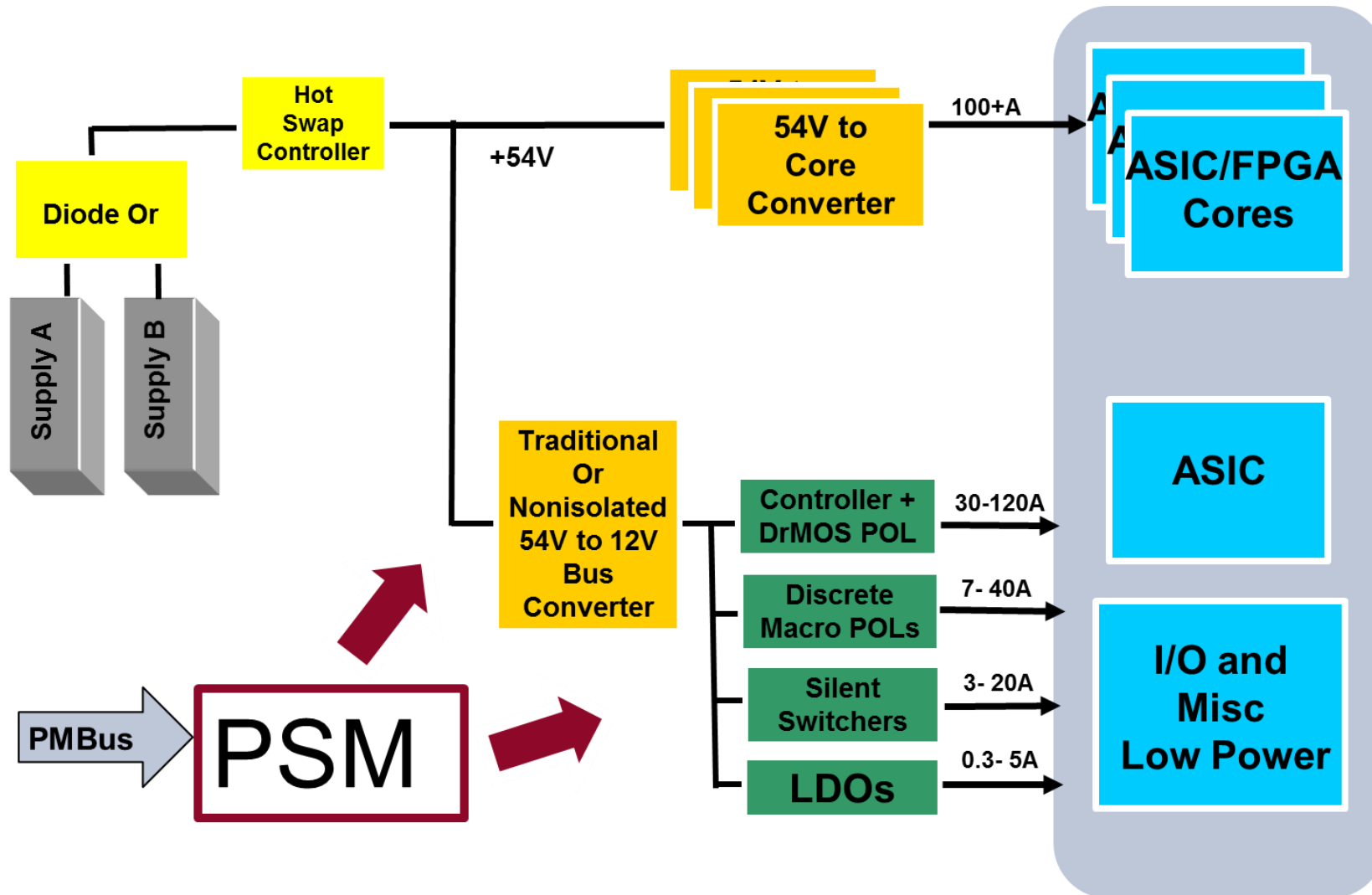

LTM4664 54V To Core Voltage Single 50A/Dual 25A μ Module with Digital PSM

- Vin range: 30V to 58V
- Vout range: 0.5V to 1.5V
- Dual outputs at 25A each or two phase single output at 50A (75W)
- Efficiency = 89% for 54Vin to 1Vout at 50A
- $\pm 0.5\%$ Vout Accuracy Over Line, Load and Temperature
 - Dual differential remote sense amplifiers
- PMBus/I2C Compliant Serial Interface for Core Voltage Outputs
- Digitally Adjustable Loop Compensation
- Programmable Voltage, Current Limit, Digital Soft-Start/Stop, Sequencing, Margining, OV, UV, OC
- 16 Bit Telemetry Read Back Includes V_{IN} and I_{IN} , V_{OUT} and I_{OUT} , Temperature and Faults with non-volatile logging
- Current Mode Control / Fast Transient Response
- 16mm x 16mm x 7.72mm BGA Package



Thank You For Watching!

샘플 및 견적문의

Web: <http://www.sheenbang.com>

E-mail: cs@sheenbang.com

Tel: 02-522-1175

담당자: ADI 한국 대리점 (주)신방 / 김형균 대리